

dsp^{ro} system



rational^o
production

MEAL
DISTRIBUTION
SPECIALISTS

Dspro System is our dissociated **convection** system composed of an on-board technology station (Dspro) and an insulated neutral shuttle (Proserv) for **hot/cold meal distribution on trays**.



Fields

Dspro System is intended for collective contexts, especially in **healthcare**, in **workplaces**, **schools** and **prisons**.



hospitals
and nursing
homes



companies



schools



prisons

Category features

01. DISSOCIATED SYSTEM

Made up of an on-board technology station and a neutral shuttle, it reduces maintenance costs over time and provides ergonomic advantages to operators.

02. HOT&COLD TRAY

Shuttle with a dividing wall to ensure proper insulation between the hot and cold parts of the tray.

03. ACTIVE CONVECTION TECHNOLOGY





Convection technology to preserve the organoleptic properties of meals both during temperature holding/boost (C&S) and regeneration cycles (C&C or C&F).

Sizes and trays

Extra small size

Small size

Large size

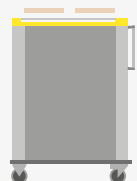
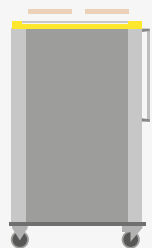
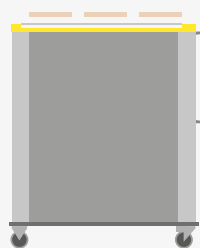
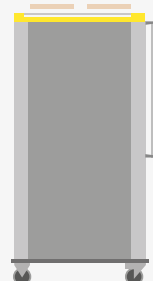
<p>DSPRO XS</p> 	<p>DSPRO S</p> 		<p>DSPRO L</p> 
<p>PROSERV XS</p> <p>14 trays pitch 91.15 mm 16 trays pitch 79 mm</p> 	<p>PROSERV S - 2T</p> <p>20 trays pitch 91.15 mm 24 trays pitch 79 mm</p> 	<p>PROSERV S - 3T</p> <p>36 trays pitch 79 mm</p> <p>Compatible trays: GN 1/1 - EXT</p> 	<p>PROSERV L</p> <p>26 trays pitch 91.15 mm 30 trays pitch 79 mm</p> 

Compatible trays

Sectioned tray

To ensure better hygiene during the entire workflow.

Flat tray

Without sections, for better ergonomics for the patient during the meal and with the possibility of increasing the hot or cold surface area as needed.

50% HOT — 50% COLD

sizes available

- GN 1/1 530x325 mm
- EXT 565x332.5 mm
- EN 1/1 530 x 370 mm (not available for Proserv S 3T)



colours

● mocha brown ● grey

50% HOT — 50% COLD (+/- 3%)

sizes available

- GN 1/1 530x325 mm



colours

● mocha brown ● grey

Cook and serve

Workflow

What it is

The C&S work system involves the preparation of hot meals just before delivery, for each service.

Dspro System ensures the correct temperature holding of hot and cold meals from the moment they are prepared to when they are delivered to the guest.

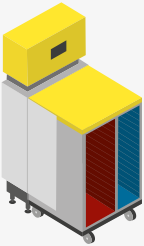

Dspro C&S
ventilated hot compartment/
ventilated cold compartment
from 3 kW to 6.5 kW

TIPS! The recommended cycle length is 20 minutes:

- +100°C for the hot compartment;
- +3°C for the cold compartment.

In case of Cook and Serve system, we recommend installing **Dspro** systems near the plating areas for two main reasons:

- the cycle is started quickly preventing temperature changes and thus ensuring correct hot/cold meal temperatures;
- holding/boost cycle speed allows various **Proserv** to be rotated on the same **Dspro**, thus limiting the number of installed **Dspro** and reducing investment.

01. PREPARATION

For each breakfast, lunch or dinner service, meals are prepared in the kitchen or in a room used for this function.

02. PLATING

Still in the kitchen or area dedicated to plating, the meals are held at a correct temperature according to HACCP standards, are divided into portions and placed on personalized trays.

03. LOADING

Ready trays are loaded in **Proserv**, to then be taken to the area where the cycle is run. During this time, **Proserv** passively holds meal temperatures.

07. CLEANING

Once it returns to the kitchen with the trays, **Proserv** is washed and sanitised, ready to be used for the next service.

06. DISTRIBUTION

At the end of the cycle, the **Proserv** shuttle is disconnected from the **Dspro** station and passively holds meal temperatures until they reach their destination where the personalised tray is distributed.

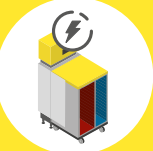

04. TEMPERATURE BOOST

Proserv is connected to the **Dspro station**. By selecting one of the various pre-programmed cycles, **Dspro system** is able to hold or even improve (if necessary) the hot and cold temperatures of the contained meals, due to the active convection system in both compartments.

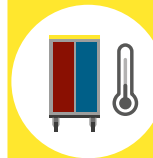

Cook and chill / Cook and freeze

Workflow

What it is

Dspro System when configured for C&C/C&F, features a multifunctional hot/cold compartment and a cold compartment, both ventilated. Recommended power from 6.5 kW to 9.8 kW.

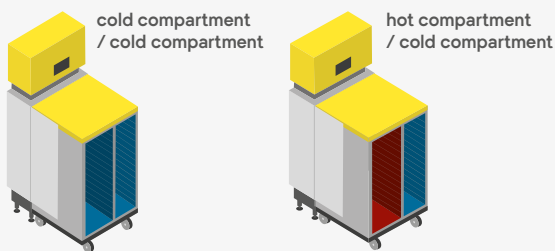

TIPS! The recommended cycle length is 45 minutes:

- +115°C for 25 minutes + 90° for 20 minutes for the hot compartment;
- +3°C for the hot compartment.

Unlike the Cook and Serve system, in case of the Cook and Chill or Cook and Freeze distribution systems, we recommend installing **Dspro** near the service area. Excellent **Proserv** shuttle insulation and meal plating in a controlled temperature room permit easy cold chain holding until the ward/regeneration area is reached, with about 60-minute autonomy (the time limit varies according to the menu/room regulations/cycles used/climate conditions).

01. MEAL COLLECTION

Meals that have been previously cooked and blast chilled are removed from the stock.



02. PLATING

In a temperature controlled area dedicated to plating the meals are divided into portions while still cold and placed on personalised trays.



03. LOADING

The still cold trays are loaded in **Proserv**, to be transported to the regeneration area. In this situation, **Proserv** passively holds meal temperatures.

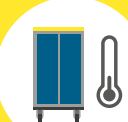

07. CLEANING

Once it returns to the kitchen with trays, **Proserv** is washed and sanitised, ready to be used for the next service.



06. DISTRIBUTION

Once the cycle ends, the personalised tray is then delivered directly to the guest without any additional handling. The tray is then collected at the end of the service.



05. REGENERATION

At a preset time, the regeneration cycle will be activated automatically. The multifunctional cold compartment switches from cold to hot, to regenerate meals at the correct HACCP temperature, while the cold compartment remains active.



04. COLD HOLDING

Proserv is connected to the **Dspro station**. **Dspro System** actively holds the cold chain in the two convection compartments.



EXTERNAL TRANSPORT

Perfect **Proserv** insulation also makes it the ideal solution for external transport (i.e. for centralised kitchens or satellite facilities) by lorry or alternative means.

Dspro features



IntelliFlow

AluFrame

Gaskets

Gaskets guarantee air seal between the hot-cold compartment and the shuttle.

EqualConvect

USB port

This provides fast configuration and firmware updates.

Condensation evaporation device

Automatic condensation evaporation system with removable tray for easy cleaning.

Easy and effortless coupling system

ECS (External Centering System)

Alignment guide for easy **Proserv** shuttle positioning by the operator.

Proximity sensor

Detects the arriving shuttle and automatically activates coupling.

Electro-mechanic coupling device

Ensures perfect station-shuttle coupling. In the event of blackout, the shuttle remains coupled, permitting manual release without tools.

Proserv features

4 doors

These allow loading from both sides with asynchronous cold and hot side opening.

Flat lid

A large surface is provided by the top with standard aluminium barriers. The maximum load is 20 kg.

Vertical ergonomic handles

For easy trolley handling (available in small and large shuttle sizes).

Dividing wall with double seal

Double seal barrier and elimination of thermal points for HACCP-proof insulation for both the hot and cold parts.



Internal chamber with rounded corners

Easy to clean thanks to its flush surfaces and wide corners, both internally as well as externally.



Perimetral bumpers

Designed to protect all parts of the trolley, especially the doors, even in an open position.

Heavy-duty castors

Available in a 4- or 6-castors model and configurable according to material type and braking system.



Design

Aesthetics

Premium, linear design available in **Yellow** or **Blue**.



Functionality

Each part of the trolley remains inside the original volume of the equipment, including optionals:

- greater ergonomics and safety for operators;
- drastic reduction of damages.

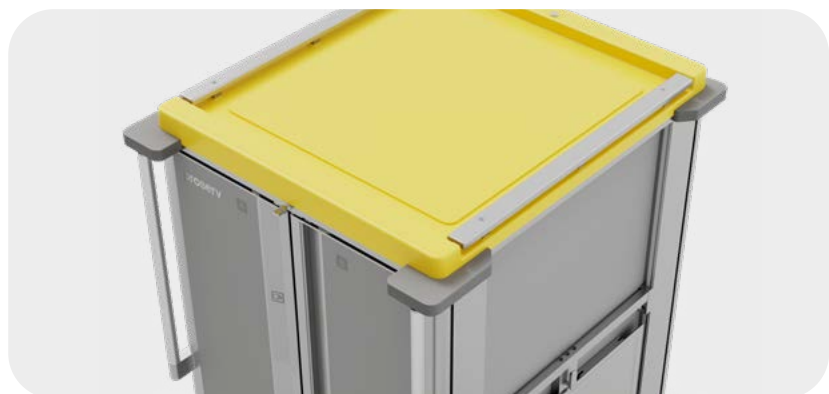

Standard technologies

equalconvect

Equalconvect is the finest convection heating technology on the market due to an array of solutions that combine our know-how in aerodynamic flows and ad hoc technical solutions for heat management.

- **Greater air flow rate** compared to market standards.
- Horizontal **airflow** and **optimised in** uniformity.
- **Axial fans** for smarter air distribution.



Greater versatility at your disposal
Equalconvect's extra airflow can be used both for optimising workflows with sprint cycles (boost cycle from 12 minutes and regeneration from 35 minutes) and for searching for optimum quality with low-temperature regenerations (from 90°C).



Balanced
 A compromise between time-quality

Quality
 Low-temperature regeneration

Speed
 Sprint cycles



Temperature uniformity
 Intelligent distribution of a greater quantity of air, compared to the market standard, conveyed in horizontal flows so as to reach each tray uniformly.



Quality and makes food appetizing
 Possibility of low-temperature regeneration to maintain the organoleptic properties of meals.

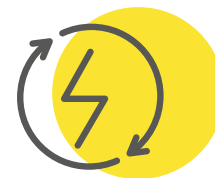

Energy saving
 25% more efficient than the previous range.

 **aluframe**

Borrowed from the world of aeronautics, **Aluframe** technology is the basis for developing a compact, lightweight, seamless perimetral frame with a structure formed by extruded anodised aluminium profiles interlocked by screwed corner joints.

- Screwed profiles for **easy dismantling**.
- Perimetral frame for greater **compactness**.
- Aluminium: **3 times lighter than steel** without compromising on **sturdiness**.
- **Recycled and recyclable** aluminium.
- The aluminium profile was designed to facilitate **the total elimination of thermal bridges** with the internal stainless steel chamber.

**Ergonomics**

Aluframe makes **Proserv** the lightest trolley on the market. It also provides extraordinary compactness, particularly in height, which benefits handling.

**Sustainable**

The frame is made with recycled aluminium and is totally recyclable at the end of product life.

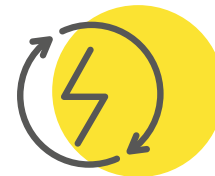
**Energy saving**

Increased product life due to the possibility of replacing individual frame profiles and improved thermal insulation thereby limiting energy consumption.

 **intelliflow**

Intelliflow is the new control system designed to be easily accessible and eliminate operating errors. Based on the Linux operating system, **Intelliflow** is our new solution for intuitive and simple control of the equipment, using a handy 7" touchscreen.



Simple and intuitive interface.



Extensive control and diagnostic system.



User friendly

Improved user-experience thanks to a software and hardware architecture that facilitates learning and minimises operating errors.



Safety

Extensive control/diagnostic system to monitor correct trolley operations according to HACCP standards.

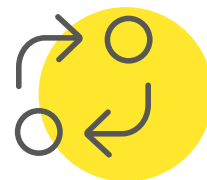

Connectivity

Possibility of connecting to peripheral devices or proprietary software, such as our **Communicator**, or even third parties, via the Linux operating system.



communicator

Communicator is the software for monitoring distribution processes according to HACCP principles and for managing the equipment fleet. **Communicator** is available in two versions according to tracking needs: **Basic** and **Premium**.

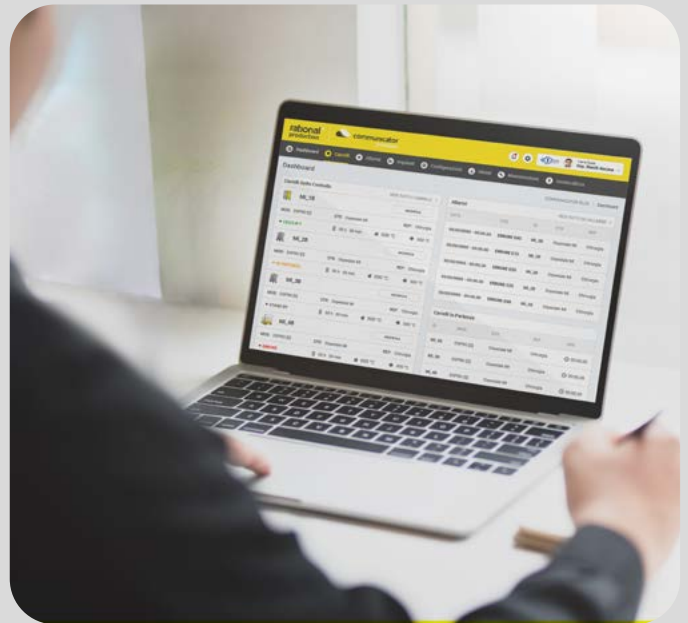

Communicator Basic

Entry-level, easy to install and use, economic, created to meet the needs of small facilities.

USB Key

-
-
-
-
-
-
-
-
-
-

Functionality

- Communication Technology
- Temperature Log
- Alarm Log
- Multi-system management
- Management personnel authorisations
- Trolley programming back-up
- Personalization of alarms and operating instructions
- Real-time monitoring
- Remote control and programming
- Installation on a local server (optional)

Communicator Premium

Complete and real-time connectivity. It enables timely remote intervention, with the possibility of keeping data on the cloud or on a local server.

Wifi

-
-
-
-
-
-
-
-
-
-



HACCP Safety

The possibility of monitoring and registering working temperatures, detecting any anomalies in advance, thus ensuring a high level of food safety and timely intervention by the operator.

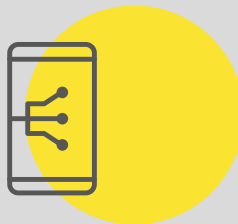

Accessibility

With the cloud-based system, operators are able to access communicator from any device in their possession.



Economic savings

Reduced costs and reduced on-site intervention time by tracking the equipment performance data and sharing it with accredited service centres.

communicator premium

Dspro connected in real-time

The real-time connection provides remote **Dspro** station control and monitoring both via software installation on cloud and server.

The connection allows temperatures and correct system operations to be controlled when the **Proserv** shuttle is coupled with the **Dspro** station.

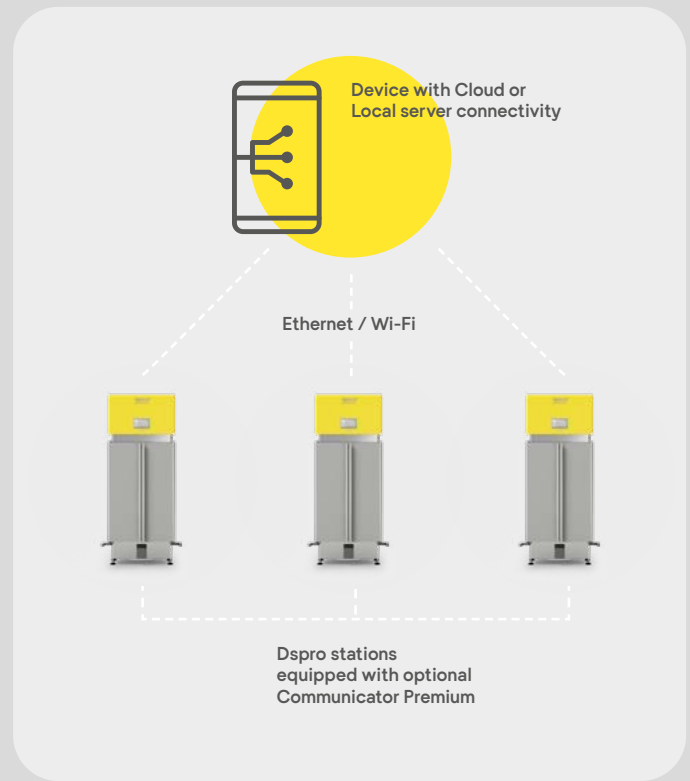

Communicator Premium for Proserv (optional)

When already installed on **Dspro** stations, **Communicator Premium** can also be added to **Proserv** shuttles to permit temperature recording during transfer from the kitchen to the station and from the station to meal delivery for improved HACCP monitoring. Data recorded in this phase will then be transmitted either via the **Dspro** station at the next connection or via Wifi upon return to the kitchen.

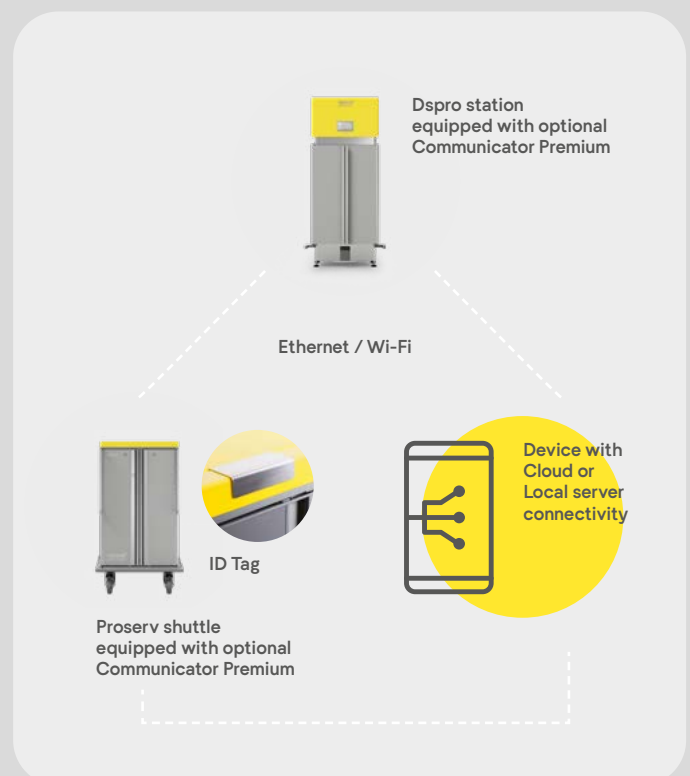

Dspro options

Installation solutions

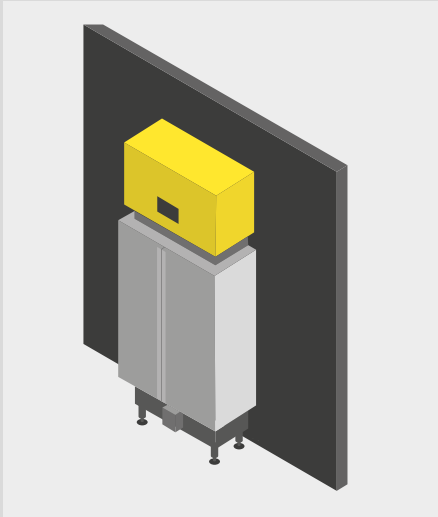

Wall mounting (standard)

Kit made up of stainless steel brackets and shock-proof elements to permit the station to be directly mounted on the wall. Ideal way to minimise the space occupied by the station.

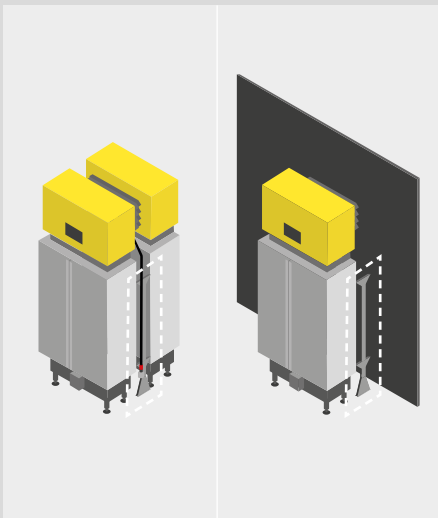

Floor-based frame (option)

Frame with shock-proof elements, purchasable separately, for two types of mounts:

- back-back, meaning between the backs of the two stations, helps to optimise space;
- near surface not suitable for direct mount such as windows, drywall, chiller walls.

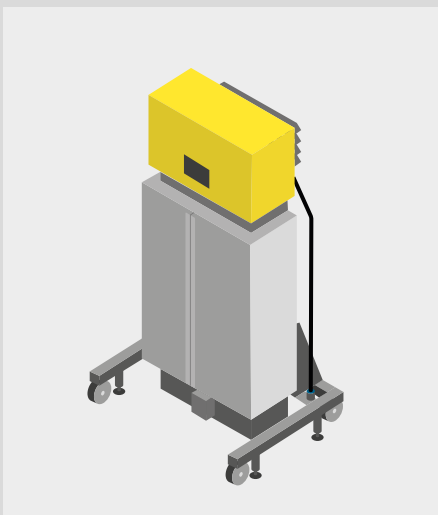

Base with castors (option)

Frame equipped with castors to move the station from its installation area when needed. Ideal option in the event movement is required between various wards or when the station is positioned on floors with drains that require access.

Dspro options



Doors

Can be installed on the station to prevent access to the hot and cold compartments, avoiding user injuries and equipment damages. The keyless blocking system is enabled via the control panel using a configurable password.



Side release button

Positioned on the side of the station, it makes station-shuttle release easy in the event the operator cannot access the control panel.

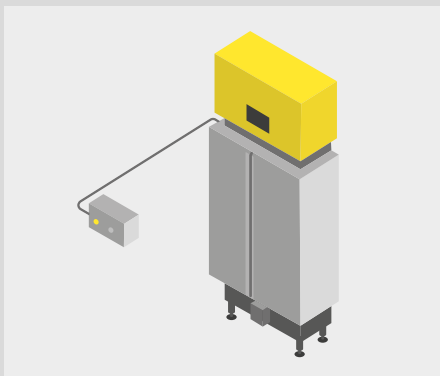

Release button and remote signal light

Two options recommended to improve ergonomics and operations for stations installed in confined spaces or with limited visibility.



Multipower

Optimisation system for energy peaks, allows the trolley's power to be cut when the temperature set is reached during the cycle.

Proserv options

Logistics solutions

Tow bar for Proserv shuttle

A stainless-steel telescopic tow bar allows up to four trolleys to be towed by one tow tractor simultaneously.

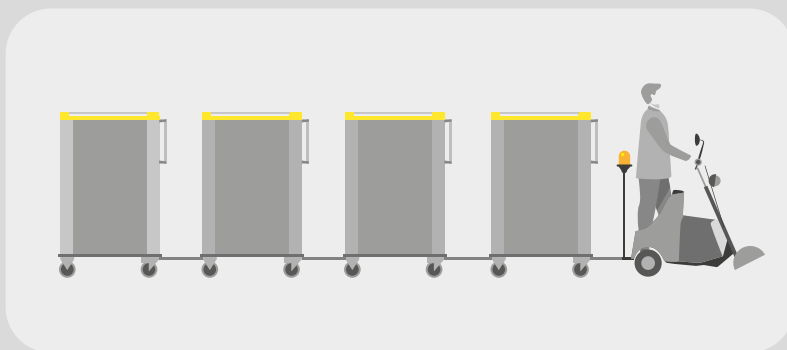

AGV/AMR

When handling using AGVs or AMRs, the trolley base can be modified according to the specifications required by the robot.

01

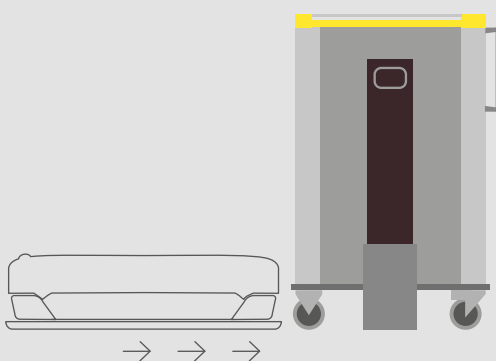

02

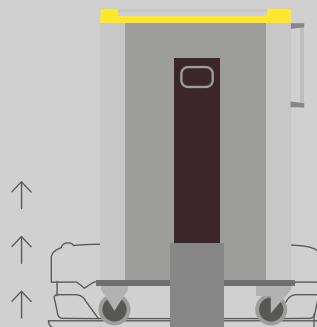

03

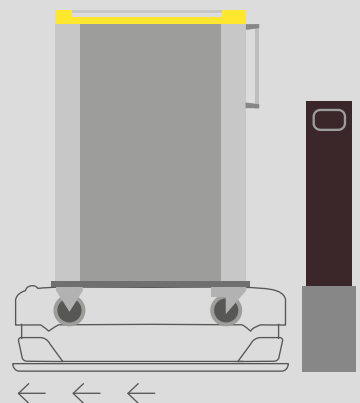

Proserv options

Washing solutions

The flush surfaces and wide corners limit the accumulation of grime and make cleaning easier, both internally and externally.

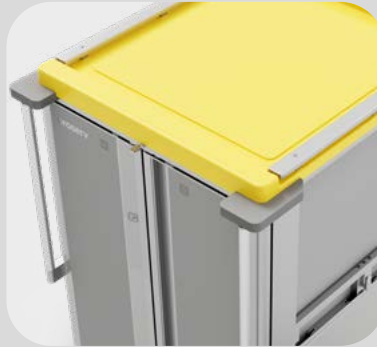

The **Proserv** shuttle, certified IPX5, can be washed in several ways, guaranteeing better management of large fleets with consequent time and cost savings.

01. IN WASHING TUNNEL

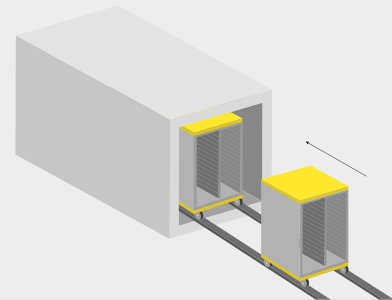

02. MANUAL

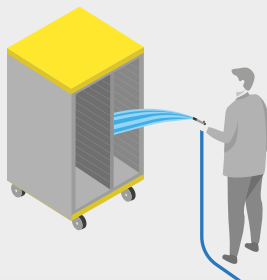

03. IN WASHING BOX

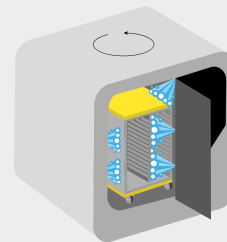

Proserv options for washing tunnel or box

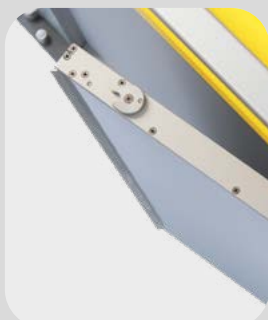

255° door opening

The option allows doors to be blocked in an intermediate opening position to enable both sides to be washed.



Swivel castors with rotation lock

Allows the shuttle to be moved 90 degrees from normal direction to optimise cleaning.

Proserv options

Castors

Quantity

4 (*standard*) 2 swivel Ø160 mm | 2 fixed Ø200 mm



6 (*optional*): 4 swivel Ø160 mm | 2 fixed Ø200 mm



Brake type

Single brake (*standard*)



Centralised brake (*optional*)



Material

Galvanised iron (*standard*)



Stainless steel (*optional*)



**Folding shelf**

Additional work surface that can be used both when distributing meals and collecting trays.

**Door lock**

Locking of doors to prevent unauthorised persons from opening them.

**Bag holder**

An accessory to the folding shelf, which can be mounted on either the right or left side, allows the housing of 1/3 GN containers or a bag that can be used when trays are collected.

**Adhesive perimetral guard**

Protective pvc band, mounted at handle height to prevent aesthetic damage to the trolley.

**Tray separation grid**

Separator between the two rows of trays, prevents food from shifting or falling during transport.

**Upper corner bumpers**

In addition to the base-mounted perimeter bumper, they provide the trolley body with additional protection.

**DS-ONE coupling setting**

Allows coupling with previous generation stations (DS-ONE).

Accessories

Crockery and lids

Standard set of high-quality crockery and matching heat-resistant polypropylene lids, designed to facilitate collective catering services, ensuring optimum performance during the heating cycle and during delivery.



ROUND DISH

Crockery size
Ø215 x 21h mm

Lid size
Ø216 x 53.5h mm



RECTANGULAR DISH

Crockery size
177 x 111 x 35h mm

Lid size
177 x 111 x 28h mm



SQUARE DISH

Crockery size
120 x 120 x 42h mm

Lid size
115 x 115 x 37h mm



ROUND BOWL

Crockery size
Ø135 x 69 mm

Lid size
Ø122 x 18h mm

LID COLOURS

Yellow



Orange



Other accessories



ID tag

Made of stainless steel, it is used to identify the trolley destination.

Available in two variants: standard and Communicator (required for Communicator Premium for Proserv shuttle).



External food core probe

Used to measure the core temperature of foods, before or after the thermal cycle.

Technical data

Dspro System	XS	S	L
Size	737 x 388 x 1508h mm	737 x 388 x 1828h mm	737 x 388 x 2066h mm
Weight	100 kg	110 kg	124 kg
Electrical power supply	380/400V or 220/230V single- or 3-phase		
Frequency	50 / 60 Hz		
Power	from 3.0 a 9.8 kW		
Hot compartment maximum temperature	+125 °C		
Cold compartment minimum temperature	-3 °C		
Index protection code (IP)	IPX4		
Certifications	CE, IEC CB Scheme		
Interior	Chambers and ventilation casing: stainless steel with wide folding range and flush fitted joints for easy cleaning. Technical compartment lined in soundproof material to reduce noise emission. Internal component layout designed to facilitate maintenance.		
Exterior	Heavy-gauge anodic oxidation-treated aluminium shell that is easily cleaned. Thermoformed ABS top cover. Impact-resistant HPL panels		
Control panel	Touch-screen display, 7 inches, with frame made of impact-resistant thermoformed ABS. 100 programmable thermal cycles.		

Proserv	XS	S 2T	S 3T	L
Size	798 x 877 x 1071h mm	798 x 914 x 1393h mm	798 x 1172 x 1393h mm	798 x 914 x 1629h mm
Dspro + Proserv dimensions	1190mm	1227mm	1485mm	1227mm
Weight	100 kg	120 kg	130 kg	130 kg
Tray capacity	14 / 16	20 / 24	36	26 / 30
Certifications	CE, IEC CB Scheme			
Interior	AISI 304 stainless steel chamber and tray support Dividing wall made of aluminium and synthetic material, heat-resistant, fully washable.			
Exterior	Heavy-gauge anodic oxidation-treated aluminium shell that is easily cleaned. Thermoformed ABS upper lid and front panel. Impact-resistant HPL panels Perimeter bumpers made of high-density polyethylene.			
Castors (standard)	Heavy duty castors with precision double ball bearings (2 swivel Ø160 mm with brake, 2 fixed Ø200 mm).			

rational^o
production

MEAL
DISTRIBUTION
SPECIALISTS

Rational Production srl
Via L. Galvani, 7/H
24061 Albano S. Alessandro (BG)
Italy

T. +39 035.452.1203
F. +39 035.452.1983
info@rationalproduction.com
www.rationalproduction.com